

PROJECT	
TYPE	
SPECIFIER	
QUANTITY	
DATE	

BIONIQ ROUND ADJUSTABLE RECESSED

A35224- _____

base number Color _____ Finishes _____
 Temperature (Diamond)

- To build a product code in our configurator select the specify button on the base model # product page
- To build a manual product code on this datasheet choose from the options listed below in blue font and add the suffix to the base model #

GENERAL

Series: Bioniq
 Subseries: Bioniq Round Adjustable
 Brand: Prolight
 Division: Architectural
 Mounting Type: Recessed
 Mounting Location: Ceiling
 Subcategory: Downlight

PHYSICAL

Shape: Round
 Diameter (mm): 107
 Diameter (in): 4 3/16
 Height (mm): 112
 Height (in): 4 7/16
 Ceiling Thickness (mm): 10 / 12.5 / 15
 Ceiling Thickness (in): 3/8 or 1/2 or 9/16
 Min. Recessing Depth (mm): 130
 Min. Recessing Depth (in): 5 1/8
 Light Distribution: Adjustable / Downlight
 Weight (kg): 0.47
 Weight (lbs): 1.04
 Fixture Finish: SSR / BKV / CWI / CRY / HAB / UFT / ITA / RUA / FTG / MYG / LOD / PUS / FRO / FUP / KIA / POP / BLS / SPG / MEY / GOH / GUM / CHC / COM / ABZ / JAG / OBR / MOS / ROR
 Fixture Material: Aluminum Die Cast
 Cut-out Measurements: 98mm / 3 7/8"

ELECTRICAL

Lamp Type: LED (Zhaga Standard)
 Input Wattage (W): 13.2 / 16.5
 Total Output Wattage (W): 12 / 15
 Dimming: Tri-Mode (Non-Dimming and Phase Dimming (120Vac only) and 0-10V Dimming)
 Driver Included: No
 Driver Location: Recessed Housing
 Driver Type: Constant Current - Universal
 Driver Class: Class 2
 Housing: See components
 Input Voltage (V): 120 - 277
 Constant Current (MA): 350

LED

Number of LEDs: 1
 Color Temperature (°K): 2700 / 3000 / 3500 / 4000
 Max. Delivered Lumen (lm): 850 / 950 / 1019 / 1040
 Nominal Lumen (lm): 960 / 1070 / 1156 / 1180
 CRI: >90 CRI
 Efficiency (%): 0.885
 Lamp Life (hrs): 50000

OPTICAL

Reflector°: 10
 Adjustability: Rotational 355°; Tilt 30°

RATINGS AND CERTIFICATIONS

Certified By: Certified for North American Standards
 IP rating: IP20

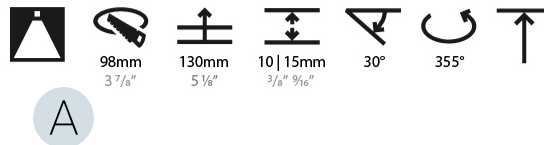

BIONIQ ROUND ADJUSTABLE RECESSED

A35224-

PROJECT	_____
TYPE	_____
SPECIFIER	_____
QUANTITY	_____
DATE	_____



PROJECT	_____
TYPE	_____
SPECIFIER	_____
QUANTITY	_____
DATE	_____

BIONIQ ROUND ADJUSTABLE RECESSED

A35233-

base number Color _____ Finishes _____
 Temperature (Diamond)

- To build a product code in our configurator select the specify button on the base model # product page
- To build a manual product code on this datasheet choose from the options listed below in blue font and add the suffix to the base model #

GENERAL

Series: Bioniq
 Subseries: Bioniq Round Adjustable
 Brand: Prolicht
 Division: Architectural
 Mounting Type: Recessed
 Mounting Location: Ceiling
 Subcategory: Downlight

PHYSICAL

Shape: Round
 Diameter (mm): 139
 Diameter (in): 5 1/2
 Height (mm): 137
 Height (in): 5 3/8
 Ceiling Thickness (mm): 10 / 12.5 / 15
 Ceiling Thickness (in): 3/8 or 1/2 or 9/16
 Min. Recessing Depth (mm): 150
 Min. Recessing Depth (in): 5 7/8
 Light Distribution: Adjustable / Downlight
 Weight (kg): 0.805
 Weight (lbs): 1.77
 Fixture Finish: SSR / BKV / CWI / CRY / HAB / UFT / ITA / RUA / FTG / MYG / LOD / PUS / FRO / FUP / KIA / POP / BLS / SPG / MEY / GOH / GUM / CHC / COM / ABZ / JAG / OBR / MOS / ROR
 Fixture Material: Aluminum Die Cast
 Cut-out Measurements: 130mm / 5 1/8"

ELECTRICAL

Lamp Type: LED (Zhaga Standard)
 Input Wattage (W): 13.2 / 16.5
 Total Output Wattage (W): 12 / 14
 Dimming: Tri-Mode (Non-Dimming and Phase Dimming (120Vac only) and 0-10V Dimming)
 Driver Included: No
 Driver Location: Recessed Housing
 Driver Type: Constant Current - Universal
 Driver Class: Class 2
 Housing: See components
 Input Voltage (V): 120 - 277
 Constant Current (MA): 350

LED

Number of LEDs: 1
 Color Temperature (°K): 2700 / 3000 / 3500 / 4000
 Max. Delivered Lumen (lm): 870 / 970 / 1039 / 1060
 Nominal Lumen (lm): 960 / 1070 / 1156 / 1180
 CRI: >90 CRI
 Efficiency (%): 0.905
 Lamp Life (hrs): 50000

OPTICAL

Reflector°: 10
 Optic°: Lens Pack - No Lens
 Adjustability: Rotational 355°; Tilt 30°

RATINGS AND CERTIFICATIONS

Certified By: CSA Certified to UL and CSA Standards
 IP rating: IP20



--	--	--	--	--	--

BIONIQ ROUND ADJUSTABLE RECESSED

A35233-

PROJECT

TYPE

SPECIFIER

QUANTITY

DATE



PROJECT	_____
TYPE	_____
SPECIFIER	_____
QUANTITY	_____
DATE	_____

BIONIQ ROUND ADJUSTABLE RECESSED

A35236-

base number Color _____ Finishes _____
 Temperature (Diamond)

- To build a product code in our configurator select the specify button on the base model # product page
- To build a manual product code on this datasheet choose from the options listed below in blue font and add the suffix to the base model #

GENERAL

Series: Bioniq
 Subseries: Bioniq Round Adjustable
 Brand: Prolight
 Division: Architectural
 Mounting Type: Recessed
 Mounting Location: Ceiling
 Subcategory: Downlight

PHYSICAL

Shape: Round
 Diameter (mm): 107
 Diameter (in): 4 3/16
 Height (mm): 112
 Height (in): 4 7/16
 Ceiling Thickness (mm): 10 / 12.5 / 15
 Ceiling Thickness (in): 3/8 or 1/2 or 9/16
 Min. Recessing Depth (mm): 130
 Min. Recessing Depth (in): 5 1/8
 Light Distribution: Adjustable / Downlight
 Weight (kg): 0.47
 Weight (lbs): 1.04
 Fixture Finish: SSR / BKV / CWI / CRY / HAB / UFT / ITA / RUA / FTG / MYG / LOD / PUS / FRO / FUP / KIA / POP / BLS / SPG / MEY / GOH / GUM / CHC / COM / ABZ / JAG / OBR / MOS / ROR
 Fixture Material: Aluminum Die Cast
 Cut-out Measurements: 98mm / 3 7/8"

ELECTRICAL

Lamp Type: LED (Zhaga Standard)
 Input Wattage (W): 13.2 / 16.5
 Total Output Wattage (W): 12 / 15
 Dimming: Tri-Mode (Non-Dimming and Phase Dimming (120Vac only) and 0-10V Dimming)
 Driver Included: No
 Driver Location: Recessed Housing
 Driver Type: Constant Current - Universal
 Driver Class: Class 2
 Housing: See components
 Input Voltage (V): 120 - 277
 Constant Current (MA): 350

LED

Number of LEDs: 1
 Color Temperature (°K): 2700 / 3000 / 3500 / 4000
 Max. Delivered Lumen (lm): 790 / 880 / 951 / 970
 Nominal Lumen (lm): 960 / 1070 / 1156 / 1180
 CRI: >90 CRI
 Efficiency (%): 0.885
 Lamp Life (hrs): 50000







OPTICAL

Reflector°: 10
 Optic°: Lens Pack - No Lens
 Adjustability: Rotational 355°; Tilt 30°

RATINGS AND CERTIFICATIONS

Certified By: Certified for North American Standards
 IP rating: IP20



					
98mm 3 7/8"	130mm 5 1/8"	10 15mm 3/8" 9/16"	30°	355°	
					

BIONIQ ROUND ADJUSTABLE RECESSED

A35236-

PROJECT

TYPE

SPECIFIER

QUANTITY

DATE



BIONIQ ROUND ADJUSTABLE RECESSED

A35245- _____

base number Color _____ Finishes _____
 Temperature (Diamond)

PROJECT
TYPE
SPECIFIER
QUANTITY
DATE

- To build a product code in our configurator select the specify button on the base model # product page
- To build a manual product code on this datasheet choose from the options listed below in blue font and add the suffix to the base model #

GENERAL

Series: Bioniq
 Subseries: Bioniq Round Adjustable
 Brand: Prolicht
 Division: Architectural
 Mounting Type: Recessed
 Mounting Location: Ceiling
 Subcategory: Downlight

PHYSICAL

Shape: Round
 Diameter (mm): 139
 Diameter (in): 5 1/2
 Height (mm): 137
 Height (in): 5 3/8
 Ceiling Thickness (mm): 10 / 12.5 / 15
 Ceiling Thickness (in): 3/8 or 1/2 or 9/16
 Min. Recessing Depth (mm): 150
 Min. Recessing Depth (in): 5 7/8
 Light Distribution: Adjustable / Downlight
 Weight (kg): 0.849
 Weight (lbs): 1.87
 Fixture Finish: SSR / BKV / CWI / CRY / HAB / UFT / ITA / RUA / FTG / MYG / LOD / PUS / FRO / FUP / KIA / POP / BLS / SPG / MEY / GOH / GUM / CHC / COM / ABZ / JAG / OBR / MOS / ROR
 Fixture Material: Aluminum Die Cast
 Cut-out Measurements: 130mm / 5 1/8"

ELECTRICAL

Lamp Type: LED (Zhaga Standard)
 Input Wattage (W): 13.2 / 16.5
 Total Output Wattage (W): 12 / 14
 Dimming: Tri-Mode (Non-Dimming and Phase Dimming (120Vac only) and 0-10V Dimming)
 Driver Included: No
 Driver Location: Recessed Housing
 Driver Type: Constant Current - Universal
 Driver Class: Class 2
 Housing: See components
 Input Voltage (V): 120 - 277
 Constant Current (MA): 350

LED

Number of LEDs: 1
 Color Temperature (°K): 2700 / 3000 / 3500 / 4000
 Max. Delivered Lumen (lm): 810 / 900 / 970 / 990
 Nominal Lumen (lm): 960 / 1070 / 1156 / 1180
 CRI: >90 CRI
 Efficiency (%): 0.905
 Lamp Life (hrs): 50000

OPTICAL

Reflector°: 10
 Adjustability: Rotational 355°; Tilt 30°

RATINGS AND CERTIFICATIONS

Certified By: Certified for North American Standards
 IP rating: IP54



--	--	--	--	--	--

BIONIQ ROUND ADJUSTABLE RECESSED

A35245-

PROJECT

TYPE

SPECIFIER

QUANTITY

DATE



PROJECT	_____
TYPE	_____
SPECIFIER	_____
QUANTITY	_____
DATE	_____

BIONIQ ROUND DEEP RECESSED

A35278- _____ - _____

base number Color _____ Finishes _____
 Temperature (Diamond)

- To build a product code in our configurator select the specify button on the base model # product page
- To build a manual product code on this datasheet choose from the options listed below in blue font and add the suffix to the base model #

GENERAL

Series: Bioniq
 Subseries: Bioniq Round Deep
 Brand: Prolight
 Division: Architectural
 Mounting Type: Recessed
 Mounting Location: Ceiling
 Subcategory: Downlight

PHYSICAL

Shape: Round
 Diameter (mm): 139
 Diameter (in): 5 1/2
 Height (mm): 151
 Height (in): 5 15/16
 Ceiling Thickness (mm): 10 / 12.5 / 15
 Ceiling Thickness (in): 3/8 or 1/2 or 9/16
 Min. Recessing Depth (mm): 170
 Min. Recessing Depth (in): 6 11/16
 Light Distribution: Downlight
 Weight (kg): 0.921
 Weight (lbs): 2.03
 Fixture Finish: SSR / BKV / CWI / CRY / HAB / UFT / ITA / RUA / FTG / MYG / LOD / PUS / FRO / FUP / KIA / POP / BLS / SPG / MEY / GOH / GUM / CHC / COM / ABZ / JAG / OBR / MOS / ROR
 Fixture Material: Aluminum Die Cast
 Cut-out Measurements: 130mm / 5 1/8"

ELECTRICAL

Lamp Type: LED (Zhaga Standard)
 Input Wattage (W): 13.2 / 16.5
 Total Output Wattage (W): 12 / 14
 Dimming: Tri-Mode (Non-Dimming and Phase Dimming (120Vac only) and 0-10V Dimming)
 Driver Included: No
 Driver Location: Recessed Housing
 Driver Type: Constant Current - Universal
 Driver Class: Class 2
 Housing: See components
 Input Voltage (V): 120 - 277
 Constant Current (MA): 350

LED

Number of LEDs: 1
 Color Temperature (°K): 2700 / 3000 / 3500 / 4000
 Max. Delivered Lumen (lm): 870 / 970 / 1039 / 1060
 Nominal Lumen (lm): 960 / 1070 / 1156 / 1180
 CRI: >90 CRI
 Efficiency (%): 0.905
 Lamp Life (hrs): 50000

OPTICAL

Reflector°: 10

RATINGS AND CERTIFICATIONS

Certified By: Certified for North American Standards
 IP rating: IP20

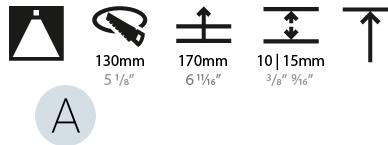
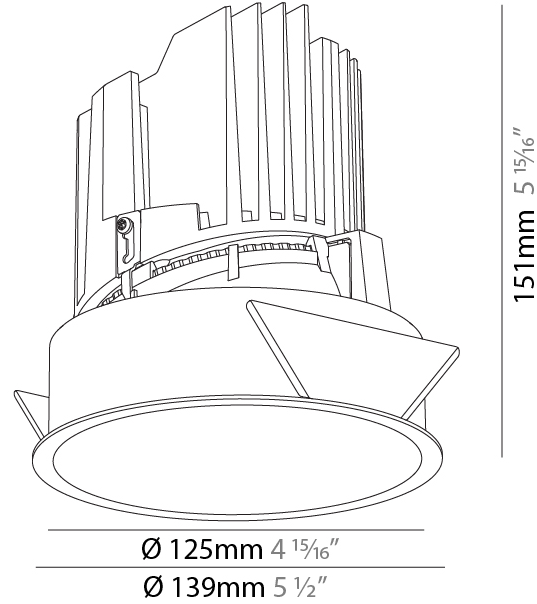

BIONIQ ROUND DEEP RECESSED

A35278-

PROJECT

TYPE

SPECIFIER

QUANTITY

DATE



A

PROJECT	_____
TYPE	_____
SPECIFIER	_____
QUANTITY	_____
DATE	_____

BIONIQ ROUND DEEP RECESSED

A35287- _____

base number Color _____ Finishes _____
 Temperature (Diamond)

- To build a product code in our configurator select the specify button on the base model # product page
- To build a manual product code on this datasheet choose from the options listed below in blue font and add the suffix to the base model #

GENERAL

Series: Bioniq
 Subseries: Bioniq Round Deep
 Brand: Prolight
 Division: Architectural
 Mounting Type: Recessed
 Mounting Location: Ceiling
 Subcategory: Downlight

PHYSICAL

Shape: Round
 Diameter (mm): 139
 Diameter (in): 5 1/2
 Height (mm): 151
 Height (in): 5 15/16
 Ceiling Thickness (mm): 10 / 12.5 / 15
 Ceiling Thickness (in): 3/8 or 1/2 or 9/16
 Min. Recessing Depth (mm): 170
 Min. Recessing Depth (in): 6 11/16
 Light Distribution: Downlight
 Weight (kg): 0.946
 Weight (lbs): 2.09
 Fixture Finish: SSR / BKV / CWI / CRY / HAB / UFT / ITA / RUA / FTG / MYG / LOD / PUS / FRO / FUP / KIA / POP / BLS / SPG / MEY / GOH / GUM / CHC / COM / ABZ / JAG / OBR / MOS / ROR
 Fixture Material: Aluminum Die Cast
 Cut-out Measurements: 130mm / 5 1/8"

ELECTRICAL

Lamp Type: LED (Zhaga Standard)
 Input Wattage (W): 13.2 / 16.5
 Total Output Wattage (W): 12 / 14
 Dimming: Tri-Mode (Non-Dimming and Phase Dimming (120Vac only) and 0-10V Dimming)
 Driver Included: No
 Driver Location: Recessed Housing
 Driver Type: Constant Current - Universal
 Driver Class: Class 2
 Housing: See components
 Input Voltage (V): 120 - 277
 Constant Current (MA): 350

LED

Number of LEDs: 1
 Color Temperature (°K): 2700 / 3000 / 3500 / 4000
 Max. Delivered Lumen (lm): 810 / 900 / 970 / 990
 Nominal Lumen (lm): 960 / 1070 / 1156 / 1180
 CRI: >90 CRI
 Efficiency (%): 0.905
 Lamp Life (hrs): 50000

OPTICAL

Reflector: 10

RATINGS AND CERTIFICATIONS

Certified By: Certified for North American Standards
 IP rating: IP54



BIONIQ ROUND DEEP RECESSED

A35287-

PROJECT

TYPE

SPECIFIER

QUANTITY

DATE



A

PROJECT	_____
TYPE	_____
SPECIFIER	_____
QUANTITY	_____
DATE	_____

BIONIQ ROUND SEMI ADJUSTABLE RECESSED

A35290- _____

base number Color _____ Finishes _____
 Temperature (Diamond)

- To build a product code in our configurator select the specify button on the base model # product page
- To build a manual product code on this datasheet choose from the options listed below in blue font and add the suffix to the base model #

GENERAL

Series: Bioniq
 Subseries: Bioniq Round Semi Adjustable
 Brand: Prolicht
 Division: Architectural
 Mounting Type: Recessed
 Mounting Location: Ceiling
 Subcategory: Downlight

PHYSICAL

Shape: Round
 Diameter (mm): 107
 Diameter (in): 4 3/16
 Height (mm): 112
 Height (in): 4 7/16
 Ceiling Thickness (mm): 10 / 12.5 / 15
 Ceiling Thickness (in): 3/8 or 1/2 or 9/16
 Min. Recessing Depth (mm): 130
 Min. Recessing Depth (in): 5 1/8
 Light Distribution: Adjustable / Downlight
 Weight (kg): 0.488
 Weight (lbs): 1.08
 Fixture Finish: SSR / BKV / CWI / CRY / HAB / UFT / ITA / RUA / FTG / MYG / LOD / PUS / FRO / FUP / KIA / POP / BLS / SPG / MEY / GOH / GUM / CHC / COM / ABZ / JAG / OBR / MOS / ROR
 Fixture Material: Aluminum Die Cast
 Cut-out Measurements: 98mm / 3 7/8"

ELECTRICAL

Lamp Type: LED (Zhaga Standard)
 Input Wattage (W): 13.2 / 16.5
 Total Output Wattage (W): 12 / 14
 Dimming: Tri-Mode (Non-Dimming and Phase Dimming (120Vac only) and 0-10V Dimming)
 Driver Included: No
 Driver Location: Recessed Housing
 Driver Type: Constant Current - Universal
 Driver Class: Class 2
 Housing: See components
 Input Voltage (V): 120 - 277
 Constant Current (MA): 350

LED

Number of LEDs: 1
 Color Temperature (°K): 2700 / 3000 / 3500 / 4000
 Max. Delivered Lumen (lm): 850 / 950 / 1029 / 1050
 Nominal Lumen (lm): 960 / 1070 / 1156 / 1180
 CRI: >90 CRI
 Efficiency (%): 0.885
 Lamp Life (hrs): 50000

OPTICAL

Reflector°: 10
 Adjustability: Rotational 355°; Tilt 10°

RATINGS AND CERTIFICATIONS

Certified By: Certified for North American Standards
 IP rating: IP20



112mm 4 7/16"

Ø 95mm 3 3/4"

Ø 107mm 4 3/16"



BIONIQ ROUND SEMI ADJUSTABLE RECESSED

A35290-

PROJECT _____

TYPE _____

SPECIFIER _____

QUANTITY _____

DATE _____



A

PROJECT	_____
TYPE	_____
SPECIFIER	_____
QUANTITY	_____
DATE	_____

BIONIQ ROUND SEMI ADJUSTABLE RECESSED

A35299- _____

base number Color _____ Finishes _____
 Temperature (Diamond)

- To build a product code in our configurator select the specify button on the base model # product page
- To build a manual product code on this datasheet choose from the options listed below in blue font and add the suffix to the base model #

GENERAL

Series: Bioniq
 Subseries: Bioniq Round Semi Adjustable
 Brand: Prolicht
 Division: Architectural
 Mounting Type: Recessed
 Mounting Location: Ceiling
 Subcategory: Downlight

PHYSICAL

Shape: Round
 Diameter (mm): 139
 Diameter (in): 5 1/2
 Height (mm): 137
 Height (in): 5 3/8
 Ceiling Thickness (mm): 10 / 12.5 / 15
 Ceiling Thickness (in): 3/8 or 1/2 or 9/16
 Min. Recessing Depth (mm): 150
 Min. Recessing Depth (in): 5 7/8
 Light Distribution: Adjustable / Downlight
 Weight (kg): 0.814
 Weight (lbs): 1.79
 Fixture Finish: SSR / BKV / CWI / CRY / HAB / UFT / ITA / RUA / FTG / MYG / LOD / PUS / FRO / FUP / KIA / POP / BLS / SPG / MEY / GOH / GUM / CHC / COM / ABZ / JAG / OBR / MOS / ROR
 Fixture Material: Aluminum Die Cast
 Cut-out Measurements: 130mm / 5 1/8"



ELECTRICAL

Lamp Type: LED (Zhaga Standard)
 Input Wattage (W): 13.2 / 16.5
 Total Output Wattage (W): 12 / 14
 Dimming: Tri-Mode (Non-Dimming and Phase Dimming (120Vac only) and 0-10V Dimming)
 Driver Included: No
 Driver Location: Recessed Housing
 Driver Type: Constant Current - Universal
 Driver Class: Class 2
 Housing: See components
 Input Voltage (V): 120 - 277
 Constant Current (MA): 350

LED

Number of LEDs: 1
 Color Temperature (°K): 2700 / 3000 / 3500 / 4000
 Max. Delivered Lumen (lm): 870 / 970 / 1039 / 1060
 Nominal Lumen (lm): 960 / 1070 / 1156 / 1180
 CRI: >90 CRI
 Efficiency (%): 90.5
 Lamp Life (hrs): 50000

OPTICAL

Reflector°: 10
 Adjustability: Rotational 355°; Tilt 10°

RATINGS AND CERTIFICATIONS

Certified By: Certified for North American Standards
 IP rating: IP20

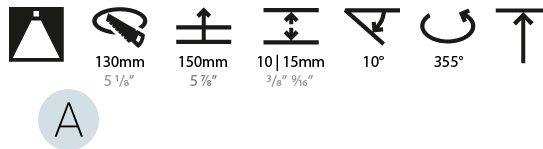

BIONIQ ROUND SEMI ADJUSTABLE RECESSED

A35299-

PROJECT

TYPE

SPECIFIER

QUANTITY

DATE



PROJECT	_____
TYPE	_____
SPECIFIER	_____
QUANTITY	_____
DATE	_____

BIONIQ ROUND SEMI ADJUSTABLE RECESSED

A35302-

base number Color Finishes
 Temperature (Diamond)

- To build a product code in our configurator select the specify button on the base model # product page
- To build a manual product code on this datasheet choose from the options listed below in blue font and add the suffix to the base model #

GENERAL

Series: Bioniq
 Subseries: Bioniq Round Semi Adjustable
 Brand: Prolicht
 Division: Architectural
 Mounting Type: Recessed
 Mounting Location: Ceiling
 Subcategory: Downlight

PHYSICAL

Shape: Round
 Diameter (mm): 107
 Diameter (in): 4 3/16
 Height (mm): 112
 Height (in): 4 7/16
 Ceiling Thickness (mm): 10 / 12.5 / 15
 Ceiling Thickness (in): 3/8 or 1/2 or 9/16
 Min. Recessing Depth (mm): 130
 Min. Recessing Depth (in): 5 1/8
 Light Distribution: Adjustable / Downlight
 Weight (kg): 0.452
 Weight (lbs): 1
 Fixture Finish: SSR / BKV / CWI / CRY / HAB / UFT / ITA / RUA / FTG / MYG / LOD / PUS / FRO / FUP / KIA / POP / BLS / SPG / MEY / GOH / GUM / CHC / COM / ABZ / JAG / OBR / MOS / ROR
 Fixture Material: Aluminum Die Cast
 Cut-out Measurements: 98mm / 3 7/8"

ELECTRICAL

Lamp Type: LED (Zhaga Standard)
 Input Wattage (W): 13.2 / 16.5
 Total Output Wattage (W): 12 / 14
 Dimming: Tri-Mode (Non-Dimming and Phase Dimming (120Vac only) and 0-10V Dimming)
 Driver Included: No
 Driver Location: Recessed Housing
 Driver Type: Constant Current - Universal
 Driver Class: Class 2
 Housing: See components
 Input Voltage (V): 120 - 277
 Constant Current (MA): 350

LED

Number of LEDs: 1
 Color Temperature (°K): 2700 / 3000 / 3500 / 4000
 Max. Delivered Lumen (lm): 790 / 880 / 950 / 970
 Nominal Lumen (lm): 960 / 1070 / 1156 / 1180
 CRI: >90 CRI
 Efficiency (%): 88.5
 Lamp Life (hrs): 50000

OPTICAL

Reflector°: 10
 Adjustability: Rotational 355°; Tilt 10°

RATINGS AND CERTIFICATIONS

Certified By: Certified for North American Standards
 IP rating: IP54

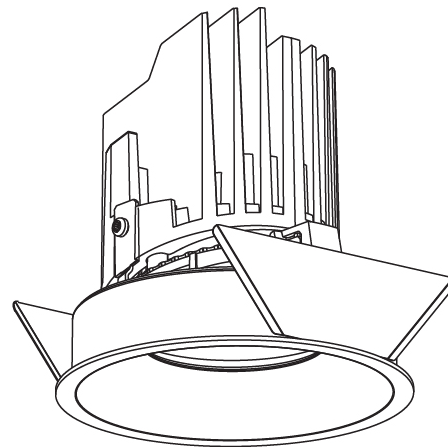

112mm 4 7/16"

Ø 95mm 3 3/4"

Ø 107mm 4 3/16"



BIONIQ ROUND SEMI ADJUSTABLE RECESSED

A35302-

PROJECT

TYPE

SPECIFIER

QUANTITY

DATE



PROJECT	_____
TYPE	_____
SPECIFIER	_____
QUANTITY	_____
DATE	_____

BIONIQ ROUND SEMI ADJUSTABLE RECESSED

A35311-

base number Color _____ Finishes _____
 Temperature (Diamond)

- To build a product code in our configurator select the specify button on the base model # product page
- To build a manual product code on this datasheet choose from the options listed below in blue font and add the suffix to the base model #

GENERAL

Series: Bioniq
 Subseries: Bioniq Round Semi Adjustable
 Brand: Prolicht
 Division: Architectural
 Mounting Type: Recessed
 Mounting Location: Ceiling
 Subcategory: Downlight

PHYSICAL

Shape: Round
 Diameter (mm): 139
 Diameter (in): 5 1/2
 Height (mm): 137
 Height (in): 5 3/8
 Ceiling Thickness (mm): 10 / 12.5 / 15
 Ceiling Thickness (in): 3/8 or 1/2 or 9/16
 Min. Recessing Depth (mm): 150
 Min. Recessing Depth (in): 5 7/8
 Light Distribution: Adjustable / Downlight
 Weight (kg): 0.851
 Weight (lbs): 1.88
 Fixture Finish: SSR / BKV / CWI / CRY / HAB / UFT / ITA / RUA / FTG / MYG / LOD / PUS / FRO / FUP / KIA / POP / BLS / SPG / MEY / GOH / GUM / CHC / COM / ABZ / JAG / OBR / MOS / ROR
 Fixture Material: Aluminum Die Cast
 Cut-out Measurements: 130mm / 5 1/8"

ELECTRICAL

Lamp Type: LED (Zhaga Standard)
 Input Wattage (W): 13.2 / 16.5
 Total Output Wattage (W): 12 / 14
 Dimming: Tri-Mode (Non-Dimming and Phase Dimming (120Vac only) and 0-10V Dimming)
 Driver Included: No
 Driver Location: Recessed Housing
 Driver Type: Constant Current - Universal
 Driver Class: Class 2
 Housing: See components
 Input Voltage (V): 120 - 277
 Constant Current (MA): 350

LED

Number of LEDs: 1
 Color Temperature (°K): 2700 / 3000 / 3500 / 4000
 Max. Delivered Lumen (lm): 810 / 900 / 970 / 990
 Nominal Lumen (lm): 960 / 1070 / 1156 / 1180
 CRI: >90 CRI
 Efficiency (%): 0.905
 Lamp Life (hrs): 50000

OPTICAL

Reflector°: 10
 Adjustability: Rotational 355°; Tilt 10°

RATINGS AND CERTIFICATIONS

Certified By: Certified for North American Standards
 IP rating: IP54



130mm 5 1/8"	150mm 5 7/8"	10 15mm 3/8" 9/16"	10°	355°		

A

BIONIQ ROUND SEMI ADJUSTABLE RECESSED

A35311-

PROJECT

TYPE

SPECIFIER

QUANTITY

DATE



BIONIQ ROUND WALLWASH RECESSED

A35344- -

base number Color Finishes
 Temperature (Diamond)

- To build a product code in our configurator select the specify button on the base model # product page
- To build a manual product code on this datasheet choose from the options listed below in blue font and add the suffix to the base model #

GENERAL

Series: Bioniq
 Subseries: Bioniq Round Wallwash
 Brand: Prolicht
 Division: Architectural
 Mounting Type: Recessed
 Mounting Location: Ceiling
 Subcategory: Wallwash

PHYSICAL

Shape: Round
 Diameter (mm): 139
 Diameter (in): 5 1/2
 Height (mm): 126
 Height (in): 4 15/16
 Ceiling Thickness (mm): 10 / 12.5 / 15
 Ceiling Thickness (in): 3/8 or 1/2 or 9/16
 Min. Recessing Depth (mm): 140
 Min. Recessing Depth (in): 5 1/2
 Light Distribution: Adjustable / Asymmetric
 Weight (kg): 0.811
 Weight (lbs): 1.79
 Fixture Finish: SSR / BKV / CWI / CRY / HAB / UFT / ITA / RUA / FTG / MYG / LOD / PUS / FRO / FUP / KIA / POP / BLS / SPG / MEY / GOH / GUM / CHC / COM / ABZ / JAG / OBR / MOS / ROR
 Fixture Material: Aluminum Die Cast
 Cut-out Measurements: 130mm / 5 1/8"

ELECTRICAL

Lamp Type: LED (Zhaga Standard)
 Input Wattage (W): 13.2 / 16.5
 Total Output Wattage (W): 12 / 14
 Dimming: Tri-Mode (Non-Dimming and Phase Dimming (120Vac only) and 0-10V Dimming)
 Driver Included: No
 Driver Location: Recessed Housing
 Driver Type: Constant Current - Universal
 Driver Class: Class 2
 Housing: See components
 Input Voltage (V): 120 - 277
 Constant Current (MA): 350

LED

Number of LEDs: 1
 Color Temperature (°K): 2700 / 3000 / 3500 / 4000
 Max. Delivered Lumen (lm): 690 / 760 / 823 / 840
 Nominal Lumen (lm): 960 / 1070 / 1156 / 1180
 CRI: >90 CRI
 Lamp Life (hrs): 50000

OPTICAL

Reflector°: 10
 Adjustability: Fixed

RATINGS AND CERTIFICATIONS

Certified By: Certified for North American Standards
 IP rating: IP20

PROJECT
TYPE
SPECIFIER
QUANTITY
DATE



126mm 4 15/16"

Ø 125mm 4 15/16"
 Ø 139mm 5 1/2"

130mm 5 1/8" 140mm 5 1/2" 10 | 15mm 3/8" 9/16" 30° ↑



BIONIQ ROUND WALLWASH RECESSED

A35344-

PROJECT

TYPE

SPECIFIER

QUANTITY

DATE



BIONIQ ROUND PINHOLE RECESSED

A37855- _____ - _____

base number Color _____ Finishes _____
 Temperature (Diamond)

- To build a product code in our configurator select the specify button on the base model # product page
- To build a manual product code on this datasheet choose from the options listed below in blue font and add the suffix to the base model #

GENERAL

Series: Bioniq
 Subseries: Bioniq Round Pinhole
 Brand: Prolicht
 Division: Architectural
 Mounting Type: Recessed
 Mounting Location: Ceiling
 Subcategory: Downlight

PHYSICAL

Shape: Round
 Diameter (mm): 139
 Diameter (in): 5 1/2
 Height (mm): 126
 Height (in): 4 15/16
 Ceiling Thickness (mm): 10 / 12.5 / 15
 Ceiling Thickness (in): 3/8 or 1/2 or 9/16
 Min. Recessing Depth (mm): 140
 Min. Recessing Depth (in): 5 1/2
 Light Distribution: Adjustable / Downlight
 Weight (kg): 0.86
 Weight (lbs): 1.9
 Fixture Finish: SSR / BKV / CWI / CRY / HAB / UFT / ITA / RUA / FTG / MYG / LOD / PUS / FRO / FUP / KIA / POP / BLS / SPG / MEY / GOH / GUM / CHC / COM / ABZ / JAG / OBR / MOS / ROR
 Fixture Material: Aluminum Die Cast
 Cut-out Measurements: 130mm / 5 1/8"

ELECTRICAL

Lamp Type: LED (Zhaga Standard)
 Input Wattage (W): 13.2 / 16.5
 Total Output Wattage (W): 12 / 15
 Dimming: Tri-Mode (Non-Dimming and Phase Dimming (120Vac only) and 0-10V Dimming)
 Driver Included: No
 Driver Location: Recessed Housing
 Driver Type: Constant Current - Universal
 Housing: See components
 Input Voltage (V): 120 - 277
 Constant Current (MA): 350

LED

Number of LEDs: 1
 Color Temperature (°K): 2700 / 3000 / 3500 / 4000
 Max. Delivered Lumen (lm): 810 / 900 / 970 / 990
 Nominal Lumen (lm): 960 / 1070 / 1156 / 1180
 CRI: >90 CRI
 Lamp Life (hrs): 50000

OPTICAL

Reflector°: 10
 Adjustability: Rotational 355°; Tilt 30°

RATINGS AND CERTIFICATIONS

Certified By: Certified for North American Standards
 IP rating: IP20

PROJECT	_____
TYPE	_____
SPECIFIER	_____
QUANTITY	_____
DATE	_____

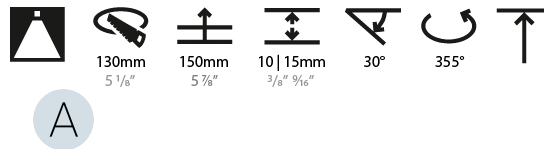

BIONIQ ROUND PINHOLE RECESSED

A37855-

PROJECT

TYPE

SPECIFIER

QUANTITY

DATE



PROJECT
TYPE
SPECIFIER
QUANTITY
DATE

BIONIQ ROUND PINHOLE RECESSED

A37861- _____
 base number Color _____ Finishes _____
 Temperature (Diamond)

- To build a product code in our configurator select the specify button on the base model # product page
- To build a manual product code on this datasheet choose from the options listed below in blue font and add the suffix to the base model #

GENERAL

Series: Bioniq
 Subseries: Bioniq Round Pinhole
 Brand: Prolicht
 Division: Architectural
 Mounting Type: Recessed
 Mounting Location: Ceiling
 Subcategory: Downlight

PHYSICAL

Shape: Round
 Diameter (mm): 107
 Diameter (in): 4 3/16
 Height (mm): 112
 Height (in): 4 7/16
 Ceiling Thickness (mm): 10 / 12.5 / 15
 Ceiling Thickness (in): 3/8 or 1/2 or 9/16
 Min. Recessing Depth (mm): 130
 Min. Recessing Depth (in): 5 1/8
 Light Distribution: Adjustable / Downlight
 Weight (kg): 0.473
 Weight (lbs): 1.04
 Fixture Finish: SSR / BKV / CWI / CRY / HAB / UFT / ITA / RUA / FTG / MYG / LOD / PUS / FRO / FUP / KIA / POP / BLS / SPG / MEY / GOH / GUM / CHC / COM / ABZ / JAG / OBR / MOS / ROR
 Fixture Material: Aluminum Die Cast
 Cut-out Measurements: 98mm / 3 7/8"

ELECTRICAL

Lamp Type: LED
 Input Wattage (W): 13.2 / 16.5
 Total Output Wattage (W): 12 / 15
 Dimming: Tri-Mode (Non-Dimming and Phase Dimming (120Vac only) and 0-10V Dimming)
 Driver Included: No
 Driver Location: Recessed Housing
 Driver Type: Constant Current - Universal
 Housing: See components
 Input Voltage (V): 120 - 277
 Constant Current (MA): 350

LED

Number of LEDs: 1
 Color Temperature (°K): 2700 / 3000 / 3500 / 4000
 Max. Delivered Lumen (lm): 850 / 950 / 1019 / 1040
 Nominal Lumen (lm): 960 / 1070 / 1156 / 1180
 CRI: >90 CRI
 Lamp Life (hrs): 50000

OPTICAL

Reflector°: 10
 Adjustability: Rotational 355°; Tilt 30°

RATINGS AND CERTIFICATIONS

Certified By: Certified for North American Standards
 IP rating: IP20

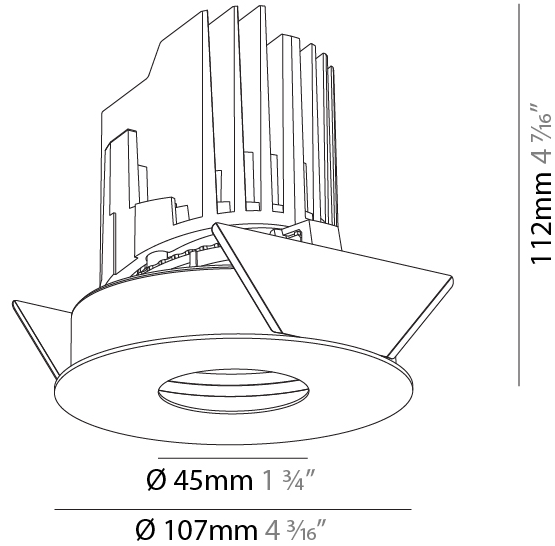

	98mm 3 7/8"	130mm 5 1/8"	10 15mm 3/8" 9/16"	30°	355°	

BIONIQ ROUND PINHOLE RECESSED

A37861-

PROJECT

TYPE

SPECIFIER

QUANTITY

DATE



PROJECT
TYPE
SPECIFIER
QUANTITY
DATE

Fixture Finish



Digital: Not all screens are calibrated the same, and therefore, colors will appear differently between screens.

Physical: When texture is involved, there will be variations in color, character and tone within a product series and between product families.

Gun Metal: No Gun Metal finish is alike. It combines a mixture of transparent and black color particles which ensures a highly individual effect and no luminaire being identical.

Champagne Cream, Copper Mine, Ancient Bronze + Jazz Gold: These finishes have slight fading from specific powder coating production. Each luminaire will slightly vary.



LEGEND

 floor-mounted	 pivotable	 special LED (upon request) RGB, RGBW, tunable, gold+, meat+, art+, fashion+
 wall and ceiling: recessed and surface mounted	 rotating	 warm dim / natural dimming LED
 ceiling-mounted and wall-mounted	 illuminate tilted	 rechargeable battery powered
 wall-mounted	 color of suspension cable	 fixture with natural vivid LED (upon request)
 omni-directional light distribution	 length of suspension cable	 color rendering index
 direct light distribution	 reflector degree selection	 color temperature
 direct/indirect light distribution	 super spot	 lumen (luminous flux)
 indirect light distribution	 lens	 efficacy (lumens per watt)
 asymmetric light distribution	 lens pack	 Unified Glare Rating (UGR) range from 5-40
 aura light distribution	 shine ring	 marine grade (AISI 316 stainless steel)
 round wall or ceiling cut-out	 integrated shine ring with diffuser	 walk on
 square wall or ceiling cut-out	 free individual colors 01-29	 drive on
 the supplied jig specifies the cutout dimensions	 individual colors: 00 (free of charge), 01-25 (extra charge)	 Dark Sky Compliance
 minimum distance (meters) lamp - object	 luminaire part to be colored (F1)	 Americans with Disabilities Act (less than 4" off the wall located between 27"-84" from floor)
 recessed depth	 luminaire part to be colored (F2)	 lamp protected against explosion
 ceiling thickness in mm	 luminaire part to be colored (F3)	 blown glass using traditional methods by master glass blower
 ceiling thickness selection	 luminaire part to be colored (F4)	 acoustic material
 dimmable DP (phase), DV (0-10V), DD (dali), DS (step-dim)	 luminaire part to be colored (F5)	 protection class I, protection insulation
 included or excluded LED driver/transformer/control gear	 color of 3-circuit adaptor	 protection class II, protection insulation
 separately switchable	 indirect diffuser	 ETL Certified to UL and CSA Standards
 sensor	 direct diffuser	 UL Certified to UL and CSA Standards
 remote control	 ball-proof (upon request)	 CSA Certified to UL and CSA Standards
 available upon request	 accessory	 Certified for North American Standards

IP RATING

 IP20	protected against ingress of solid bodies greater than 12.5mm (finger)
 IP33	protected against ingress of solid bodies greater than 2.5mm protected against sprays of water up to 60 degrees from the vertical (rain)
 IP40	protected against ingress of solid bodies greater than 1mm (wire) no protection against the ingress of moisture
 IP43	protected against ingress of solid bodies greater than 1mm (wire) protected against sprays of water up to 60 degrees from the vertical (rain)
 IP44	protected against ingress of solid bodies greater than 1mm (wire) protected against water splashed from all directions
 IP54	protected against limited ingress of dust (wet rooms/covered outdoor areas) protected against water splashed from all directions
 IP65	protected against ingress of dust protected against jets of water
 IP66	protected against ingress of dust protected against powerful jets of water or heavy seas
 IP67	protected against ingress of dust protected against immersion of water between 15cm - 1m for 30 minutes
 IP68	protected against ingress of dust protected against immersion of water under pressure for long periods

IK RATING

 IK01	protected against 0.14 joules impact (equivalent to 0.25kg mass dropped from 56mm above the surface)
 IK02	protected against 0.2 joules impact (equivalent to 0.25kg mass dropped from 80mm above the surface)
 IK03	protected against 0.35 joules impact (equivalent to 0.25kg mass dropped from 140mm above the surface)
 IK04	protected against 0.5 joules impact (equivalent to 0.25kg mass dropped from 200mm above the surface)
 IK05	protected against 0.7 joules impact (equivalent to 0.25kg mass dropped from 280mm above the surface)
 IK06	protected against 1 joules impact (equivalent to 0.25kg mass dropped from 400mm above the surface)
 IK07	protected against 2 joules impact (equivalent to 0.5kg mass dropped from 400mm above the surface)
 IK08	protected against 5 joules impact (equivalent to 1.7kg mass dropped from 300mm above the surface)
 IK09	protected against 10 joules impact (equivalent to 5.0kg mass dropped from 200mm above the surface)
 IK10	protected against 20 joules impact (equivalent to 5.0kg mass dropped from 400mm above the surface)